

Contact Us

Tanner's Crossing Planning District

Box 1072
2nd Floor, Civic Centre
103 Main Street South
Minnedosa, MB R0J 1E0

Phone: 204.867.2364
Cell: 204.867.7980
Fax: 204.867.5543
Email: tcpd@mymts.net
Web: <http://www.minnedosa.com/index.php?pageid=133>

Or contact the following member jurisdictions of Tanner's Crossing Planning District.

R.M. of Minto-Odanah

49 Main Street South
Minnedosa, MB R0J 1E0
Phone: 204.867.3865
Phone: 204.867.3282

Town of Minnedosa

103 Main Street South
Minnedosa, MB R0J 1E0
Phone: 204.867.2727

Wood Decks

Construction guidelines for non-sheltered wood decks for residential dwellings



Tanner's Crossing Planning District

Foundation

Notes:

What type of foundations are normally used for wood decks?

In general, the foundation closed for a wood deck consists of either surface pads or piers.

What are some advantages and disadvantages of a surface pad foundation?

Advantages: Surface foundations are relatively easy to install, inexpensive and less disruptive to existing landscape.

Disadvantages: Over time, as a result of shifting soil conditions or settlement, movement will occur making releveling necessary.

Therefore, if your long range plans are to enclose all or a portion of your deck with a screened-in area, sunroom or extension to your dwelling, and the enclosed area will be attached to the main dwelling via the walls or the roof, it is suggested that you use a pile or pier foundation as described further in this pamphlet, or that you retain a Professional Engineer registered in the Province of Manitoba to design an adequate foundation.

Should you decide to retain an Engineer, bring two copies of the Engineer's design under seal and signature when applying for your building permit.

FIGURE 1

Surface Pad

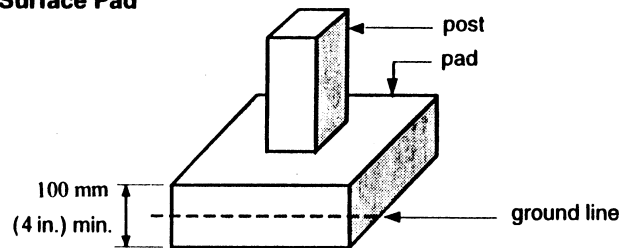

What is the difference between a built-in bench and a chair or a table?

If a chair or a table are in a hazardous position, you have the option of moving them. A built-in bench does not give you that option.

Are guardrails required for stairs?

Stairs with more than six risers and which exceed 600 mm (2 ft.) above the finished ground level also require guardrails. These guards are to be at least 900 mm (35") in height measured vertically above a line drawn through the outside edges of the stair nosing. If the stairs have an intermediate landing, the guardrail must be at least 900 mm (35") in height over the landing area. Openings situated below these heights are to be such as to prevent the passage of a spherical object having a diameter of 100 mm (4").

Will the stair also require a handrail?

The Building Code states that if any outside stair has more than three risers, a handrail is required on one side of the stair. As shown in Figure 10, the handrail is required to be a minimum of 900 mm (35") in height measured vertically above a line drawn through the outside edges of the stair nosing. Stairs with three risers or fewer do not require handrails.

In those cases where a stair also requires a guardrail, a reasonable solution is to provide a guardrail, which also acts as a handrail.

FIGURE 8

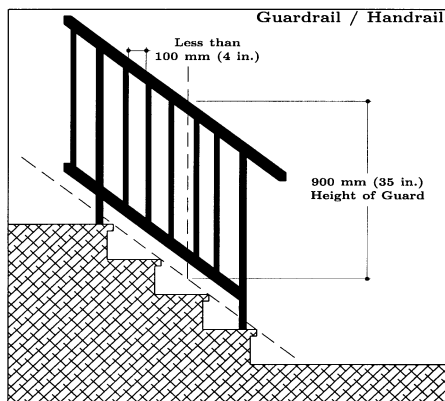

What are the recommendations for a surface pad foundation?

Surface pads should be made of concrete or other material which will not prematurely deteriorate as a result of contact with the soil. As shown in Figure 1, they should be a minimum 100 mm (4") thick and be installed so that the top surface is slightly above adjacent finished ground level in order to prevent premature deterioration of the post or beam which will be bearing on the pad.

Refer to Table 1 to determine the recommended foundation pad size. Foundation pads are available at most lumber dealers.

What are some of the advantages and disadvantages of a pile or pier foundation?

Advantages: Movement of the deck will be minor, thus making releveling highly unlikely. Piles or piers could satisfy the requirements for a foundation to a dwelling addition.

Disadvantages: Piles or piers are considerably more expensive and disruptive to existing landscape.

TABLE 1
Recommended Deck Foundation Pad Sizes ⁽¹⁾

Maximum Supported Joist Length ⁽²⁾	Concrete Surface Pad Size (length x width x thickness)	Maximum Supported Joist Length ⁽²⁾	Concrete Surface Pad Size (length x width x thickness) (mm)
4 ft.	12 in. x 12 in. x 4 in.	1.22 m	300 x 300 x 100
10 ft.	18 in. x 18 in. x 6 in.	3.05 m	450 x 450 x 150
16 ft.	24 in. x 24 in. x 6 in.	4.88 m	600 x 600 x 150

Notes:

- (1) This table requires beams with supports every 2.44 m (8 ft.) or less.
- (2) Supported joist length means half the span of joists supported by the beam plus the length of the overhang beyond the beam. (See Figure 5)

FIGURE 2

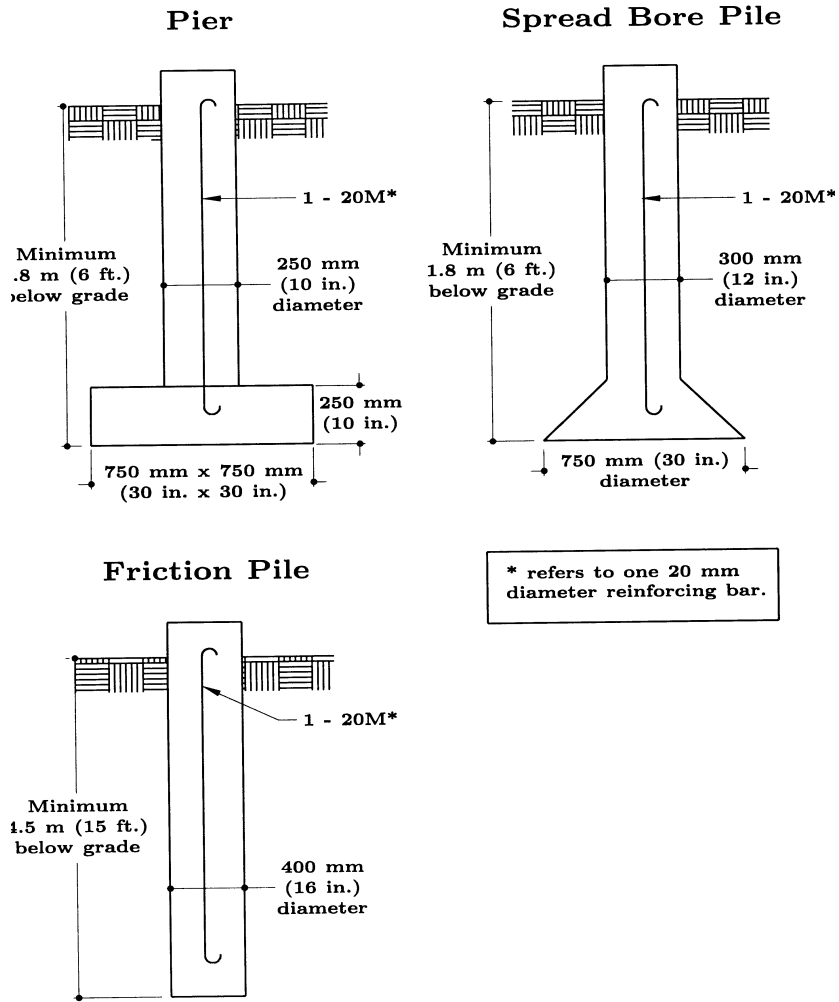
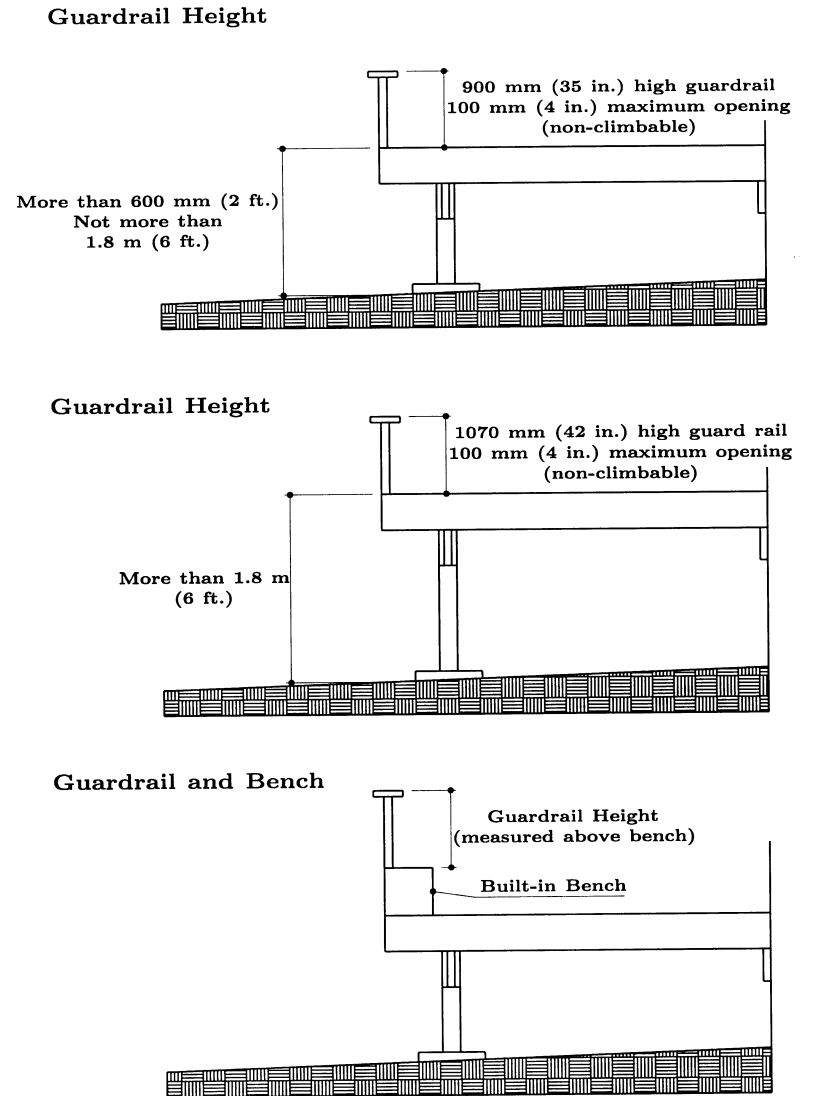

FIGURE 7



- (b) Decks with floor surfaces which are more than 600 mm (2 ft.) but not more than 1.8 m (6 ft.) above the finished ground level at any point around their perimeter requires a guardrail at least 900 mm (35") in height. (See Figure 7).

Openings to the underside of the top horizontal member of the guardrail must be such as to prevent the passage of a spherical object having a diameter of 100 mm (4").

- (c) Decks with floor surfaces which are more than 1.8 m (6 ft.) above finished ground level at any point around their perimeter require a guardrail at least 1070 mm (42") in height. (See Figure 7).

Openings to the underside of the top horizontal member of the guardrail must be such as to prevent the passage of a spherical object having a diameter of 100 mm (4").

There must be no member or attachment between 100 mm (4") and 900 mm (35") measured from the floor surface of the deck which will facilitate climbing.

Can a built-in bench serve as a guardrail?

No, unless a guardrail meeting the previously described height and opening requirements is provided above the flat surface of the bench and any openings below the bench also meet the maximum opening requirements. (See Figure 7).

What are the requirements for a pile or pier foundation?

Piles or piers must be in accordance with Figure 2 as shown, or alternatively, be designed by a Professional Engineer.

How far apart can these pads, piles, or piers be installed?

The location of the pads, piles, or piers can vary depending on the size and type of material used for the beam that spans from one pad, pile, or pier to the other; and the amount of floor area that each individual pad, pile, or pier is required to carry. The examples shown in Figure 3 are based on the beam supports having a maximum spacing of 2.44 m (8 ft.) on centre. The beam table that follows indicates beams which are adequate for this spacing.

FIGURE 3

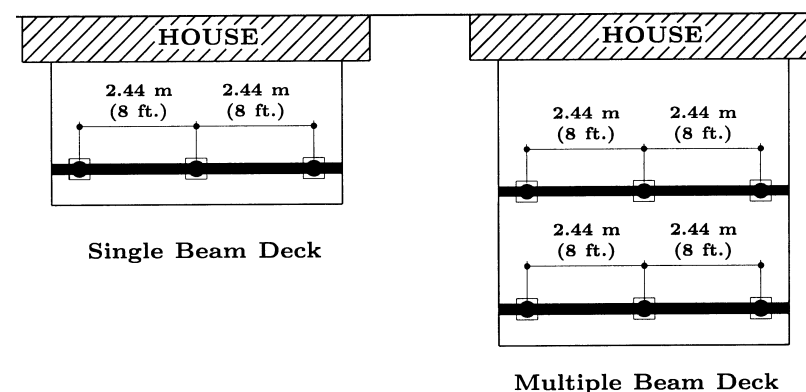

Can I vary from this 2.44 m (8 ft.) spacing?

Yes, you can place the pads, piles, or piers closer together and still maintain the beam sizes used in this publication for 2.44 m (8 ft.) spacing. Alternatively, if you wish to place them further apart, you would have to install a beam which is adequate for that longer span. The beam sizes indicated in this publication have been calculated using common engineering principles. Other variations are possible provided the deck is designed and installed to carry a live load of 1.9 kPa40 psf).

If you wish to increase the spacing of the pads, piles, or piers, or if you wish to reduce the beam sizes indicated in the beam tables, you may have to retain someone who is familiar with the required engineering calculations. Whichever design you choose, it must be indicated on your plans at the time of your building permit application.

Can I use multiples of the 2.44 m (8 ft.) spacing and make my deck deeper and/or wider?

Yes you can, provided you continue to meet all of the same construction requirements and provided you do not exceed the area that is permitted for your particular property.

What size posts should I use, and how should they be anchored?

Posts, if used, should be at least the width of the beam, centered on the pad, pile, or pier, and securely fastened to the beam by means of toe nailing, wood gussets, angle brackets, or other equivalent methods. Where posts exceed 1.22 m (4 ft.) in length, they should be braced to each other, or up to the beam and floor, or alternatively, they should be anchored to the pad, pile, or pier in order to prevent them from shifting at the bottom.

What size of beams do I need?

The beam table, Table 2, is intended for single beam decks and multiple beam decks having supports at 2.44 m (8 ft.) intervals along the beam. See also Figure 5.

Design

Are there any requirements for stairs?

The Building Code requires that treads and risers have uniform rise and run in any one flight, with riser heights not exceeding 200 mm (8"). The Building Code also requires the minimum run of each tread to be 210 mm (8¼") and the minimum tread width to be 235 mm (9¼"). See Figure 6 for details.

What is the difference between guardrails and handrails?

Guardrails are intended to prevent persons from falling off the edge of a stair or a raised floor area such as a deck. The guardrail must be able to withstand the pressure of a human body applied horizontally against it.

Handrails are required to assist persons in ascending or descending stairs. They offer a continuous handhold to support persons who may stumble on the stair.

Will my deck require guardrails?

The need for guardrails is determined according to the height of the deck floor surface above the finished ground level as follows:

- (a) Decks with floor surfaces that do not exceed 600 mm (2 ft.) above the finished ground level at any point around their perimeter do not require guardrails.

FIGURE 6

Stair Detail

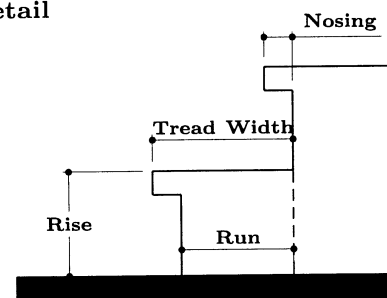

**IF: The run is less than 250 mm (10 in.)
THEN: A nosing of at least 25 mm (1 in.) must be provided.**

Another item you should take into consideration when selecting the type, size, and spacing of your floor joists is the type of material that you intend to use as decking. Check with your lumber dealer to ensure that the decking you select will not sag significantly between the joists as a result of the joist spacing you have chosen.

TABLE 3
DECK FLOOR JOIST SPANS⁽¹⁾
Design Floor Live Loads for 1.9 kPa (40 psf)

Commercial Designation	Grade	Member Size (in.)	Joist Spacing			Member Size (mm)	Joist Spacing (mm)		
			12" ft-in	16" ft-in	24" ft-in		300 m	400 m	600 m
Douglas Fir - Larch	No. 1 & No. 2	2 x 6	13-5	11-9	9-8	38 x 140	4.08	3.60	2.94
		2 x 8	16-7	14-4	11-9	38 x 184	5.06	4.38	3.58
		2 x 10	20-4	17-7	14-4	38 x 235	6.19	5.36	4.38
Spruce-Pine-Fir	No. 1 & No. 2	2 x 6	12-9	11-7	10-1	38 x 140	3.89	3.53	3.08
		2 x 8	16-9	15-3	12-9	38 x 184	5.11	4.64	3.89
		2 x 10	21-5	19-1	15-7	38 x 235	6.52	5.82	4.75
Column 1	2	3	4	5	6	7	8	9	10

Note:

- (1) This table applies to outdoor decks above grade only, and assumes a minimum of 1 inch decking material. The figures in this table do not correspond to those found in Appendix A of the National Building Code, (Floor Joists and Built-up Floor Beams).

Structural

TABLE 2
DECK BEAM SIZES⁽¹⁾
Design Floor Live Loads for 1.9 kPa (40 psf)

Maximum Supported Joist Length ⁽²⁾	Beam Size ⁽³⁾	Maximum Supported Joist Length ⁽²⁾	Beam Size ⁽³⁾
8 ft.	3 - 2 x 8	2.44 m	3 - 38 x 184 mm
10 ft.	3 - 2 x 8	3.05 m	3 - 38 x 184 mm
12 ft.	3 - 2 x 8 or 2 - 2 x 10	3.66 m	3 - 38 x 184 mm or 2 - 38 x 235 mm
14 ft.	4 - 2 x 8	4.27 m	4 - 89 x 184 mm
16 ft.	3 - 2 x 10 or 2 - 2 x 12	4.88 m	3 - 38 x 235 mm or 2 - 38 x 286 mm

Notes:

- (1) This table requires beams with supports every 2.44 m (8 ft.) or less.
 (2) Supported joist length means half the span of joists supported by the beam plus the length of the overhang beyond the beam. (See Figure 5).
 (3) This table is for use with Spruce-Pine-Fir lumber grades 1 and 2.

Can I have joints in the beam?

Yes. However, when joints are necessary, they should be situated on a support (post). On multiple-ply laminated beams the joints should be staggered so that joints occur on alternate supports. If it is intended to project the beam beyond the end supports, there should be no joints on the end support.

How far can I project the beam beyond the end support?

The beam can project up to a maximum of 600 mm (2 ft.) beyond the end support.

FIGURE 4
JOINT LOCATIONS IN BUILT-UP BEAMS

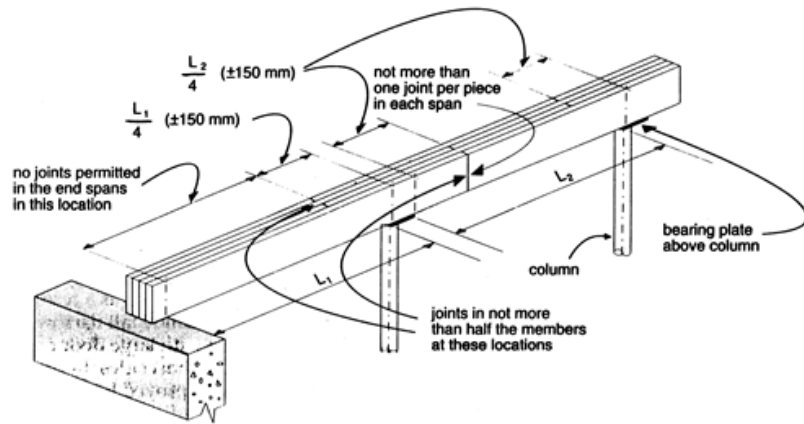

How should beam laminations be nailed together?

Individual members must be nailed together with a double row of nails at least 89 mm (3 ½ in.) in length, spaced not more than 450 mm (18 in.) apart in each row. End nails must be located between 100 mm (4 in.) and 150 mm (6 in.) from the end of each piece.

How far can the joists project beyond the face of the outside beam?

If you are planning to eventually enclose all or a portion of the deck with a roofed structure which could carry snow, the Building Code states that the joists can only project 400 mm (16") where 2 x 8 joists are used, and 600 mm (2 ft.) where 2 x 10 or larger joists are used. The projection of 2 x 6 joists would require engineering analysis to determine if the floor assembly would be sufficient to carry the super-imposed roof loads.

FIGURE 5

Single Beam Deck

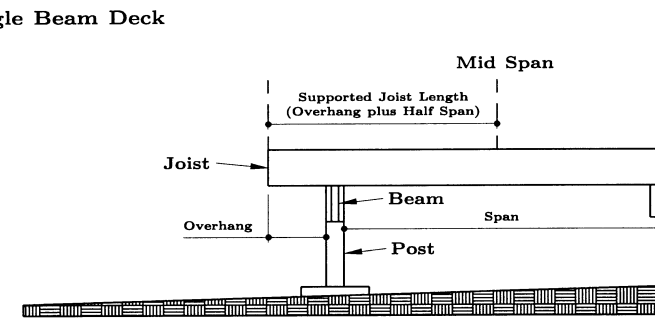

Multiple Beam Deck

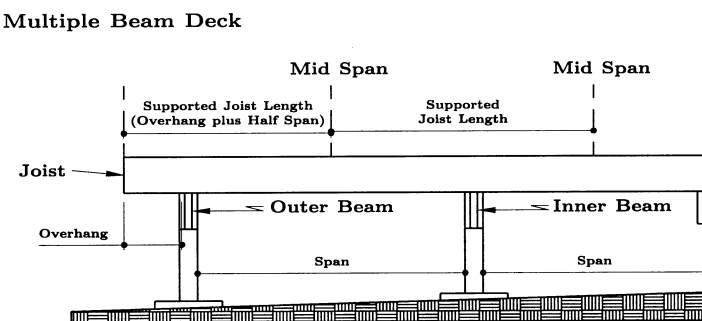

What size of floor joists do I require?

The size of the floor joists are governed by the distance they have to span, and the spacing at which the floor joists are installed. Table 3 indicates some common species and sizes of wood and the acceptable span distances for wood decks. Joist spans are measured from face of support to face of support (in the case of a wood deck, from face of beam to face of beam, or from face of beam to face of ledger).